

5 Drawer Chest

1010201

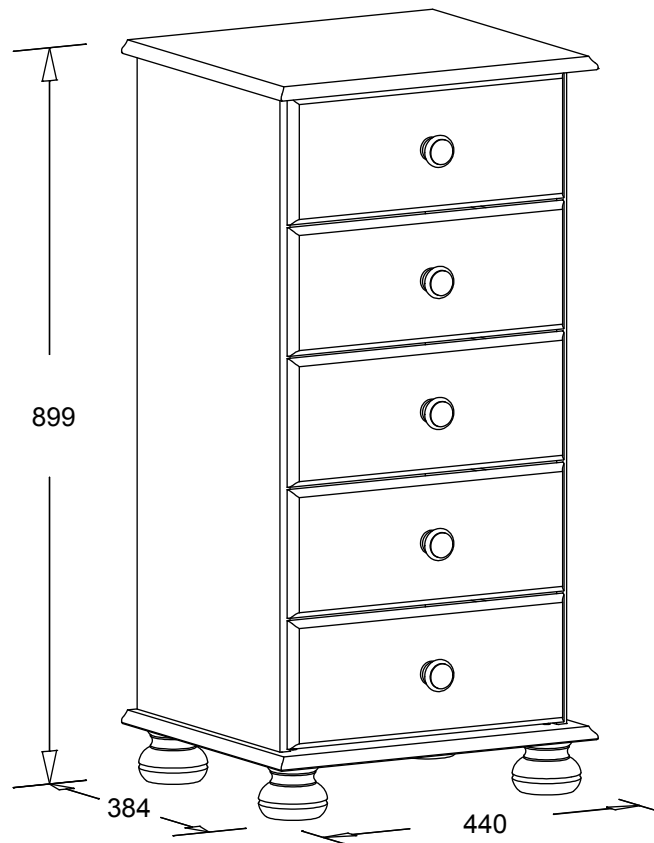

Important!

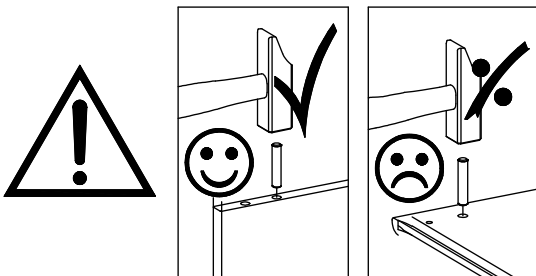

Please, read the assembly instruction carefully, before assembling.

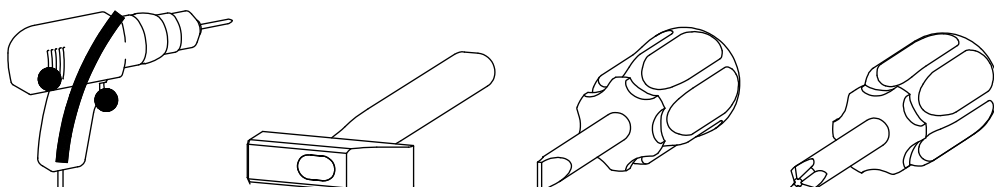

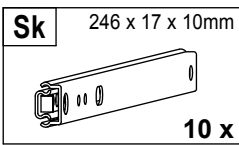
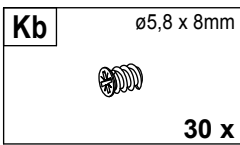
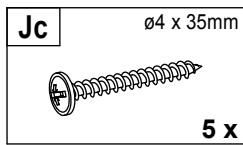
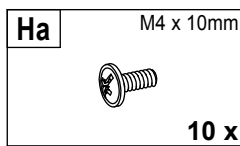
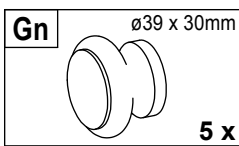
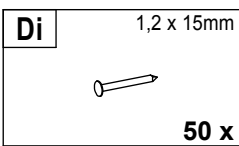
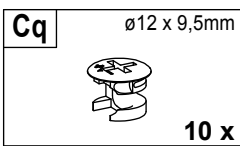
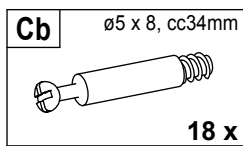
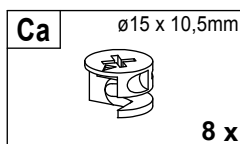
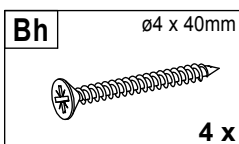
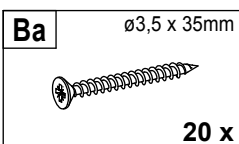
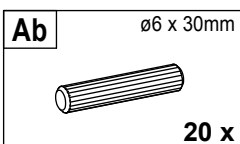
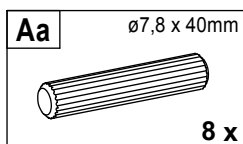
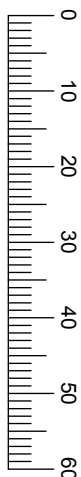
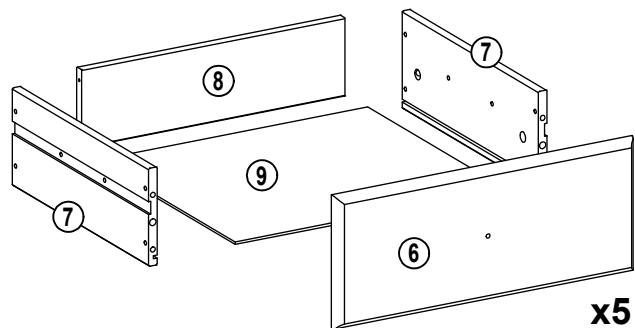
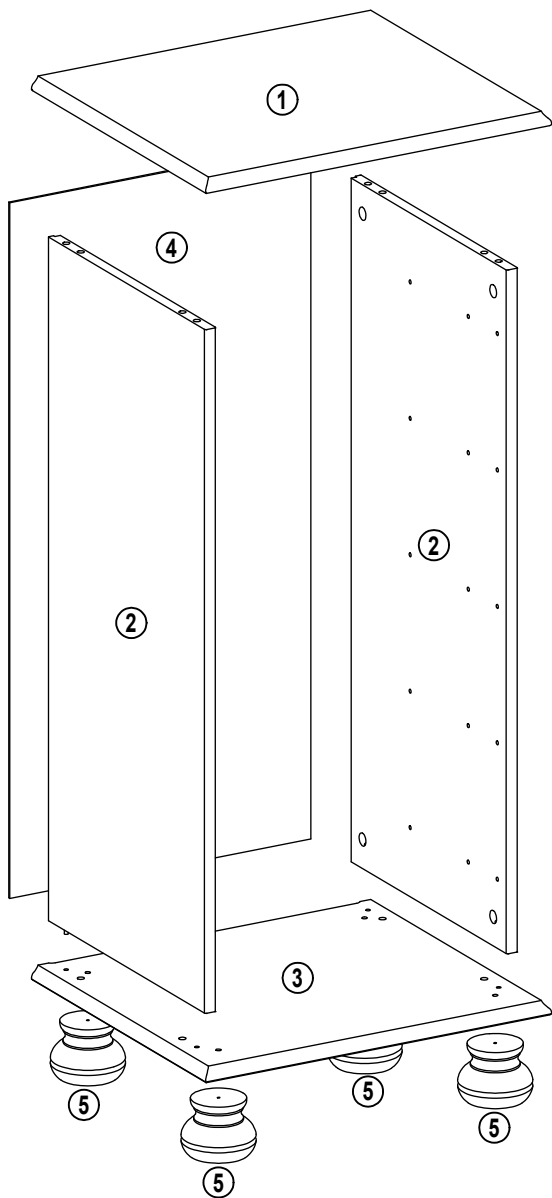

1

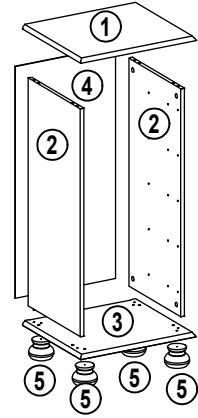
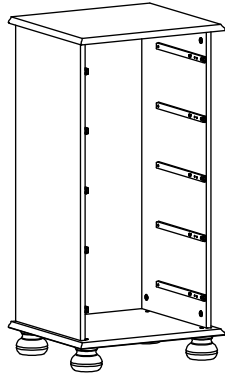

1.1

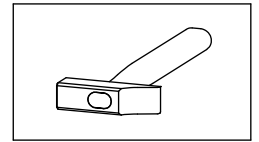
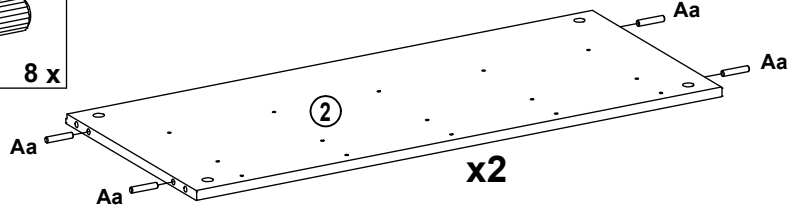
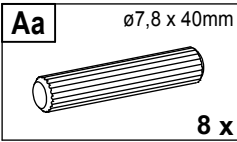

1.2

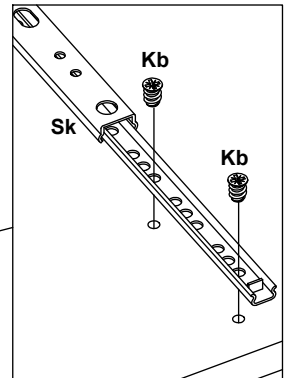
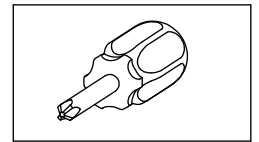
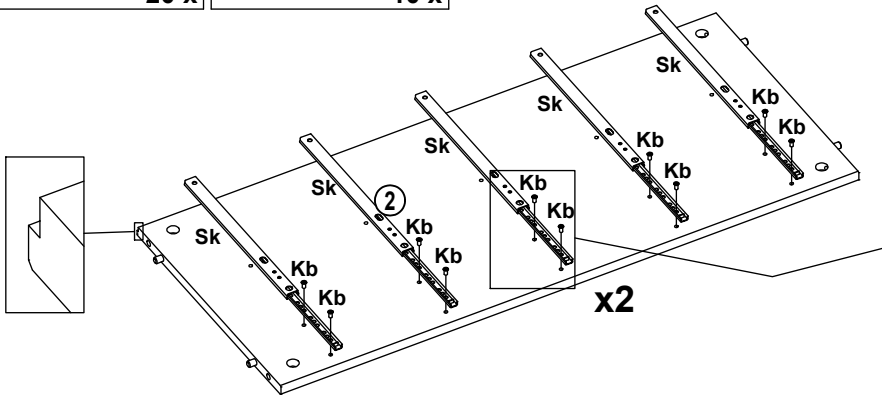
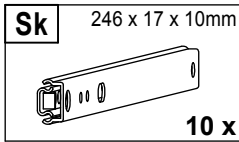
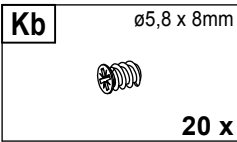

1.3

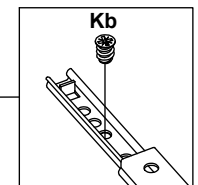
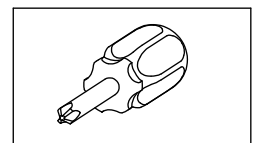
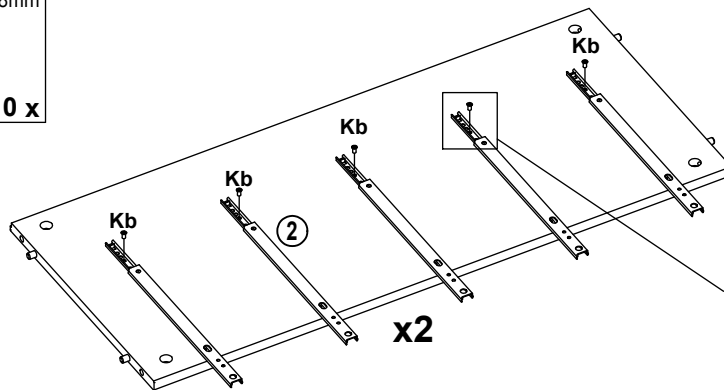
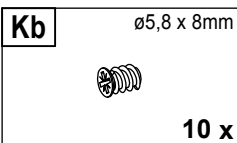

1.4

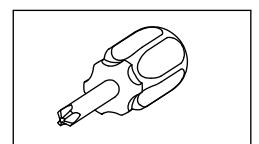
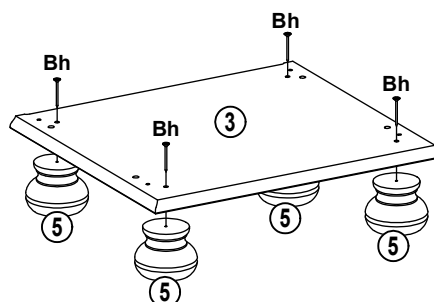
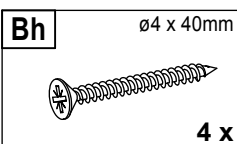

1.5

Cb $\varnothing 5 \times 8, cc34mm$
8 x

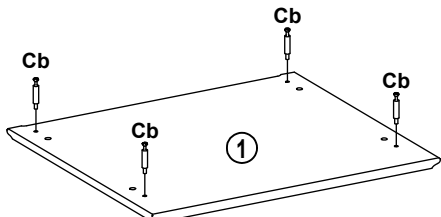
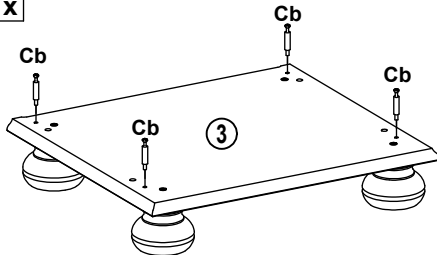
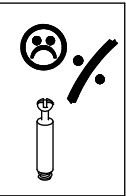
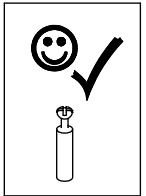
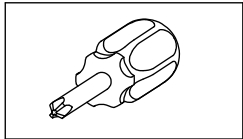

1.6

Ca $\varnothing 15 \times 10,5mm$
8 x

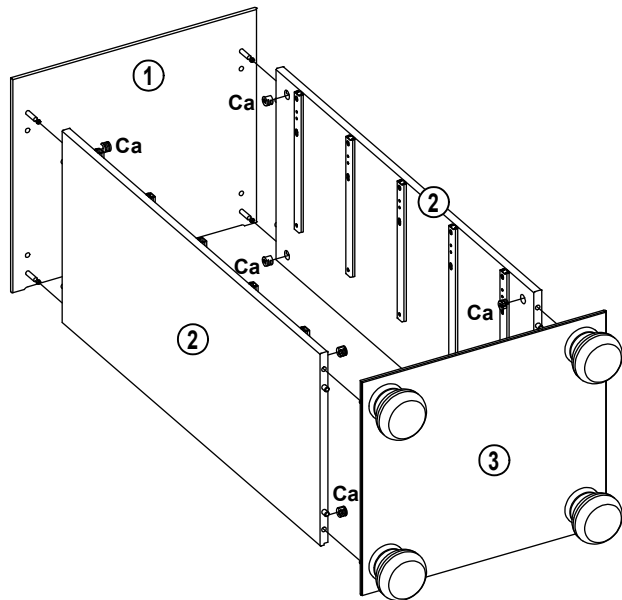
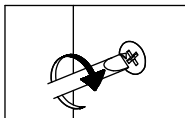
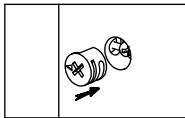
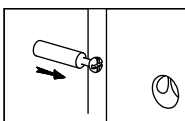
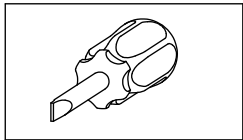

1.7

Di 1,2 x 15mm
20 x

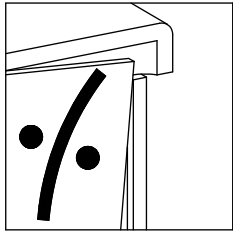
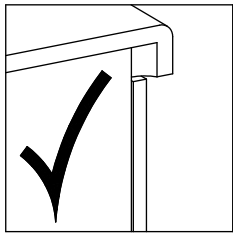
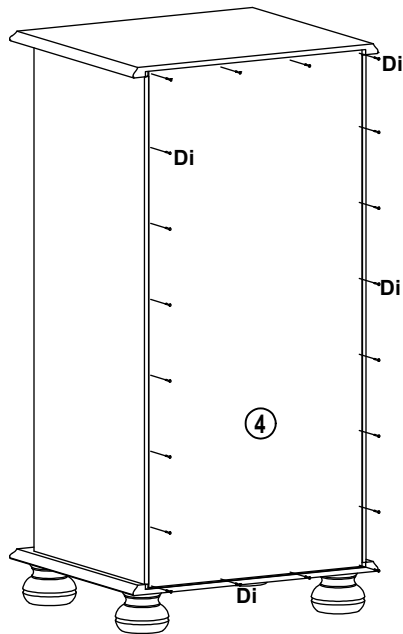
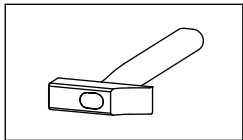

1.8

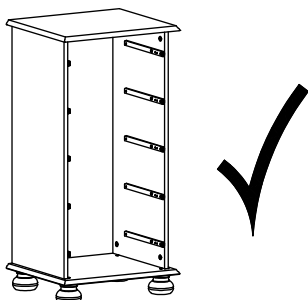

2

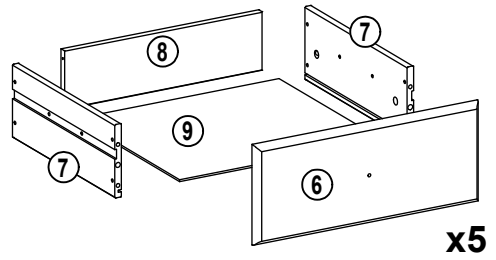
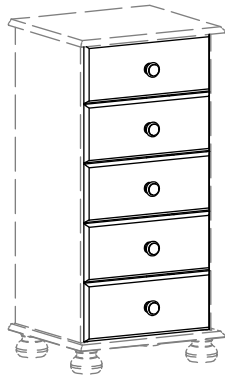

2.1

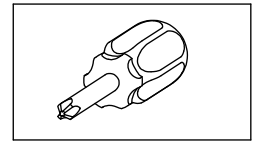
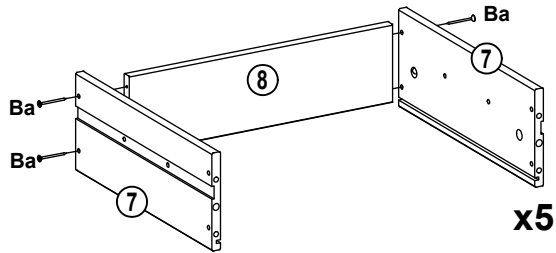
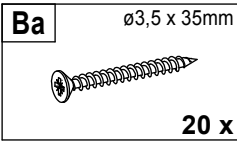

2.2

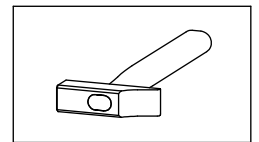
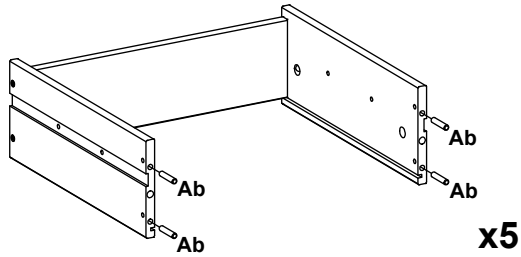
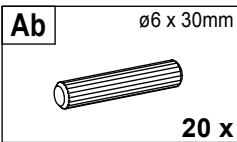

2.3

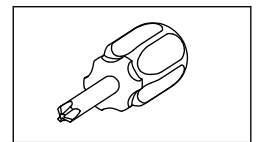
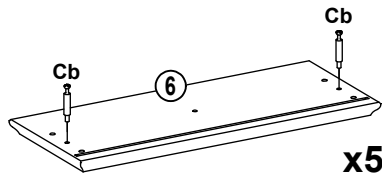
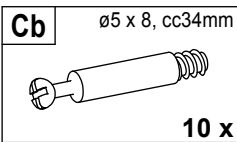

2.4

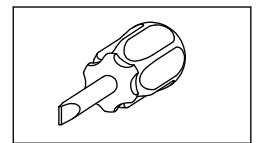
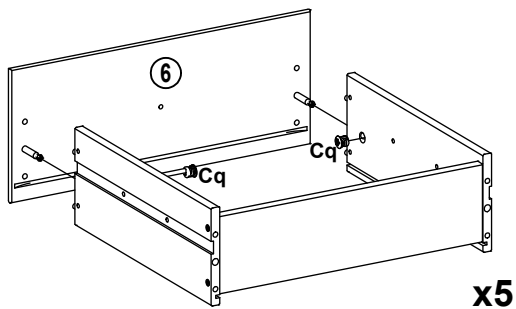
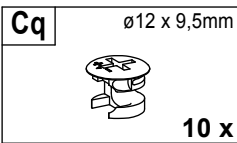

2.5

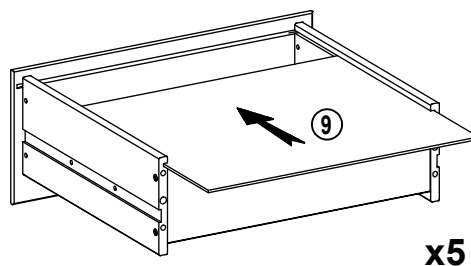

2.6

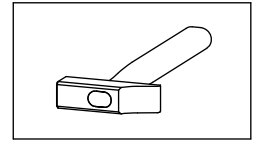
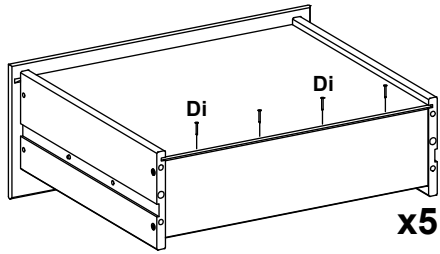
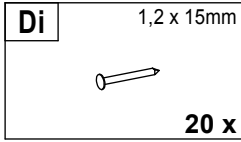

2.7

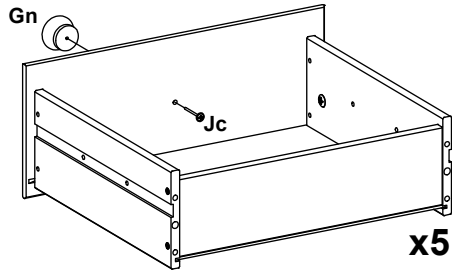
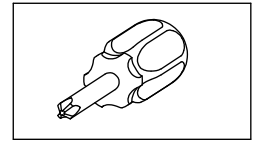
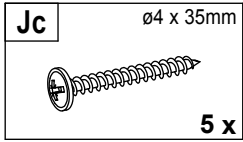
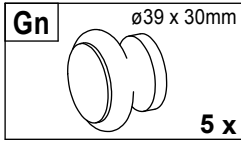

2.8

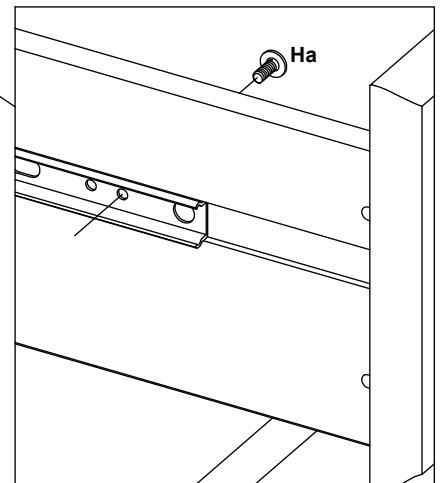
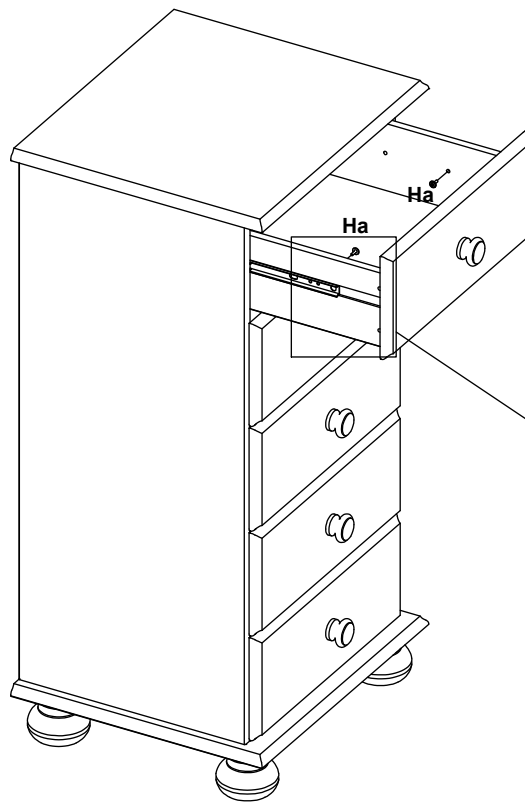
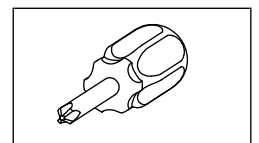
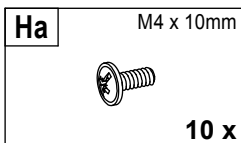

2.9

